

Embedding Strings in the Unknot

By José María MONTESINOS-AMILIBIA*

Dedicated with respect and friendship to Professor Yukio Matsumoto on his 60th birthday

Abstract. In this paper, the possibility of embedding a non trivial string (\mathbb{R}^3, K) in the trivial knot (\mathbb{S}^3, U) is investigated. Uncountably many examples are given. The complementary space in \mathbb{S}^3 of the image of \mathbb{R}^3 under the embedding is a continuum. Some well known snake-like continua appear as these residual spaces. The 2-fold coverings of \mathbb{R}^3 branched over the strings involved are studied. As a consequence, concrete descriptions of the p-adic solenoids are given, and it is shown that the Whitehead continuum is homeomorphic to Bing's snake-like continuum without end points.

1. Introduction

A closed set C in a 3-manifold M is *tame* if there is a homeomorphism of M in itself sending C onto a subcomplex of some locally finite simplicial complex triangulating M . If there is no such homeomorphism, we say that C is *wild*. A *knot* is a pair (\mathbb{S}^3, N) , where N is a tame subspace of the 3-sphere \mathbb{S}^3 homeomorphic to the 1-sphere \mathbb{S}^1 . A *string* is a pair (\mathbb{R}^3, K) , where K is a tame subspace of the real 3-space \mathbb{R}^3 properly homeomorphic to the real line \mathbb{R}^1 . A knot (\mathbb{S}^3, N) is the *unknot* if N bounds a tamely embedded disk in \mathbb{S}^3 . A string (\mathbb{R}^3, K) is the *trivial string* if it bounds a tamely embedded half-plane in \mathbb{R}^3 . We say that a string (\mathbb{R}^3, K) *lies in the unknot* $(\mathbb{S}^3, \mathbb{S}^1)$ if there is a (topological) embedding $f : \mathbb{R}^3 \rightarrow \mathbb{S}^3$ mapping K homeomorphically onto a subspace of \mathbb{S}^1 . A *wild knot* is a pair (\mathbb{S}^3, N) , where N is a wild subspace of the 3-sphere \mathbb{S}^3 homeomorphic to the 1-sphere \mathbb{S}^1 .

1991 *Mathematics Subject Classification.* Primary 57M30, 54F15; Secondary 57M25, 57N60.

*Supported by BMF-2002-04137-C02-01.

Of course, the trivial string lies in the unknot, but *is there a non trivial string lying in the unknot?* It turns out that this question has a positive answer, and it uncovers a curious relationship between strings and continua.

A *continuum* is a compact, connected, metric space with more than one point. A *chain* is a finite and linearly ordered collection of (no necessarily connected) open sets such that two members of the collection intersect if and only if they are consecutive. The chain is called an ϵ -*chain* if the links of the chain are of diameter less than ϵ . A continuum is called *snake-like* (*SL* in short) if for each positive number ϵ it can be covered by an ϵ -chain. We call a point \mathbf{p} of a SL-continuum \mathbf{X} an *end-point* if, for each positive number ϵ , \mathbf{X} can be covered by an ϵ -chain such that only the first link of the chain contains \mathbf{p} .

Snake-like continua were first defined and studied by R.H.Bing in [1] who gave a number of examples with special properties. We are interested in Examples 6 and 7 of that paper. Example 6 is a *SL-continuum with only one end point*, while Example 7 is a *SL-continuum without end points*. We will denote these continua, respectively, by \mathbf{S} and \mathbf{W} . They were defined as particular subspaces of \mathbb{R}^2 .

The above mentioned relationship between non trivial strings lying in the unknot and continua can be stated as follows. *If (\mathbb{R}^3, K) is a string lying in the unknot $(\mathbb{S}^3, \mathbb{S}^1)$ then there exists a compact, connected space \mathbf{X} such that (i) \mathbf{X} is cellularly embedded in \mathbb{S}^3 ; (ii) $\mathbf{X} \cap \mathbb{S}^1$ is an arc or a point; and (iii) $(\mathbb{S}^3 - \mathbf{X}, \mathbb{S}^1 - \mathbf{X})$ is homeomorphic to (\mathbb{R}^3, K) .* If \mathbf{X} is a singleton then $(\mathbb{S}^3 - \mathbf{X}, \mathbb{S}^1 - \mathbf{X})$ is the trivial string. We will offer uncountably many almost unknotted strings lying in the unknot. Their corresponding continua \mathbf{X} will be SL-continua similar to \mathbf{S} .

An obvious necessary condition for a non trivial string (\mathbb{R}^3, K) to lie in the unknot is that, for any positive integer m , the m -cyclic covering of \mathbb{R}^3 branched over K is an open 3-manifold that can be embedded in \mathbb{S}^3 , (and this was the starting point of our investigations). Using this, we will exhibit uncountably many almost unknotted strings having no embedding in the unknot (and, in fact, in any tame knot). That condition will be used also to give concrete descriptions of two famous continua: the *dyadic solenoid* and the *Whitehead continuum*. In particular, we will show that the Whitehead continuum is homeomorphic to Bing's SL-continuum \mathbf{W} without end points.

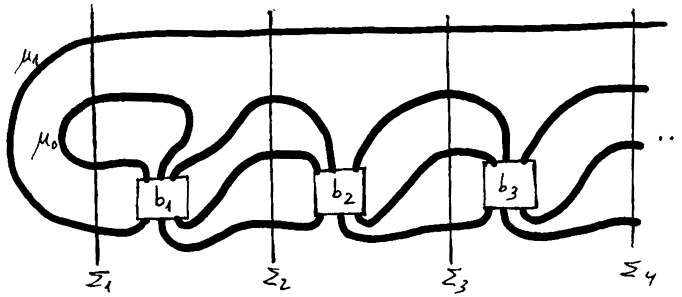

Fig. 1. The string (\mathbb{R}^3, K_{JI}) .

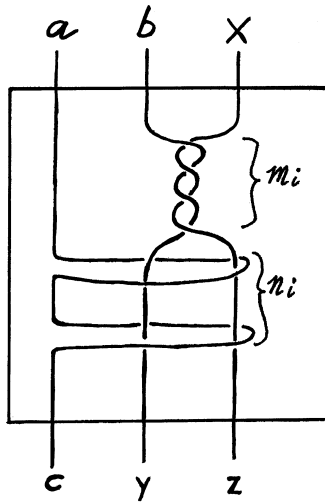

Fig. 2. The box $b_i = \sigma_2^{-2m_i} (\sigma_1 \sigma_2^2 \sigma_1)^{-n_i}$.

2. Some Non Trivial Strings

DEFINITION 1. Given an integer sequence $I = \{n_i\}_{i=1}^\infty$ and a sequence of half integers $J = \{m_i\}_{i=1}^\infty$, we define the string (\mathbb{R}^3, K_{JI}) as the string depicted in Figure 1. The box b_i is depicted in Figure 2; it denotes the 3-braid $\sigma_2^{-2m_i} (\sigma_1 \sigma_2^2 \sigma_1)^{-n_i}$, with $m_i = -\frac{3}{2}$, $n_i = 2$.

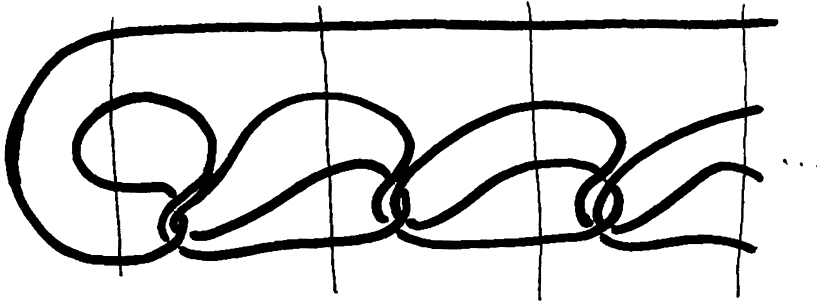

Fig. 3. $I = \{1, 1, 1, \dots\}, J = \{0, 0, 0, \dots\}$.

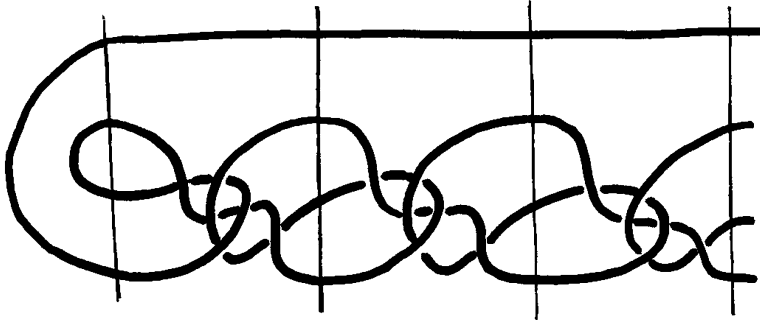

Fig. 4. $I = J = \{1, 1, 1, \dots\}$.

For instance, Figure 3 shows (\mathbb{R}^3, K_{JI}) for $m_i = 0$ and $n_i = 1$ for all i . Figure 4 shows (\mathbb{R}^3, K_{JI}) for $m_i = 2/2$ and $n_i = 1$ for all i , and Figure 5 shows (\mathbb{R}^3, K_{JI}) for $m_i = 4/2$ and $n_i = 2$ for all i .

REMARK 2. If the sequence I is the zero sequence, then certainly (\mathbb{R}^3, K_{JI}) is the trivial string. If the sequence I contains the zero sequence as a subsequence, the (\mathbb{R}^3, K_{JI}) is the trivial string also (see Figure 6).

PROPOSITION 3. *If the sequence I is an odd sequence, that is, n_i is odd for every i , then $\pi_1(\mathbb{R}^3 - K_{JI})$ has an epimorphism onto the dihedral group of order $2p$, for any odd integer $p \geq 3$, sending meridians to elements of order 2. This epimorphism is unique up to conjugation. In particular the*

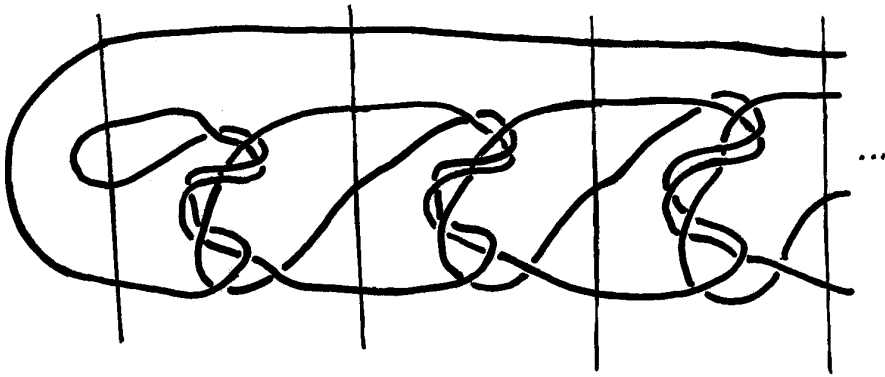

Fig. 5. $I = J = \{2, 2, 2, \dots\}$.

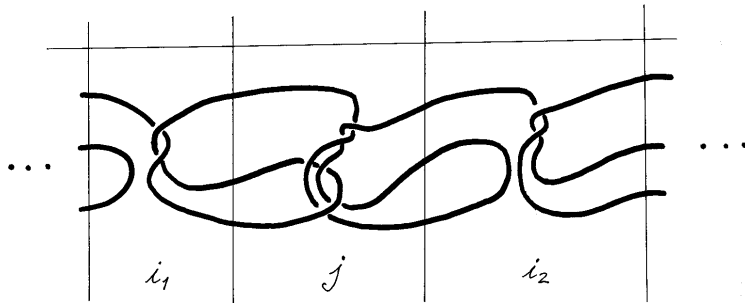

Fig. 6. Part of a zero subsequence.

string (\mathbb{R}^3, K_{JI}) is not trivial.

PROOF. Start assigning to the meridians μ_0, μ_1 of Figure 1 two different elements of order two of the dihedral group D_{2p} of order $2p$. Then, there exists a unique assignment of elements of order two to the remaining (infinite) Wirtinger generators of $\pi_1(\mathbb{R}^3 - K_{JI})$ due to the following remark. *In the 3-braid of Figure 2 there is exactly one solution $\{x, y, z\}$, for any elements $\{a, b, c\}$ of order 2, compatible with the Wirtinger relations, if n_i is odd.* The proof of this remark reduces to solving linear equations mod. p and can be reproduced easily by the reader taking into account the following observation of Fox. Think of D_{2p} as a subgroup of the symmetric group of p

indices $\{1, 2, \dots, p\}$ in such a way that an element of order 2 fixes precisely one index $i \in \{1, 2, \dots, p\}$. Denote an element of order 2 by the index i that it fixes. Then, to find an epimorphism of the group of a knot, or string (in normal projection), onto \mathcal{D}_{2p} sending meridians to elements of order 2 we only need to assign an index of $\{1, 2, \dots, p\}$ to each overpass of the projection provided that the following conditions are satisfied: (i) at least two indices are used, and (ii) for each crossing point of the projection, twice the index of the overpass equals mod. p the sum of the indices of the two adjacent underpasses. \square

DEFINITION 4. According to Fox [6], a string (\mathbb{R}^3, K) is almost unknotted if it is homeomorphic to a string (\mathbb{R}^3, K_1) having the following property. For any 3-cell U in \mathbb{R}^3 there is a 3-cell $V \supset U$ and a homeomorphism h of \mathbb{R}^3 on itself such that (i) h is the identity in $\mathbb{R}^3 - \text{Int}V$, and (ii) $h(K_1 \cap V)$ is a subset of a fixed plane in \mathbb{R}^3 . (In particular, ∂V lies in the fixed plane.)

PROPOSITION 5. For any sequence I , the string (\mathbb{R}^3, K_{II}) is almost unknotted.

PROOF. Note that the 3-braid $\sigma_2^{-2n_i}(\sigma_1\sigma_2^2\sigma_1)^{-n_i} = (\sigma_2\sigma_1\sigma_2)^{-2n_i}$. The details are left to the reader. See Figures 4 and 5. \square

COROLLARY 6. The strings $(\mathbb{R}^3, K_{I_1I_1})$ and $(\mathbb{R}^3, K_{I_2I_2})$ are homeomorphic if the sequences I_1 and I_2 are cofinal.

COROLLARY 7. The p -fold irregular covering of \mathbb{R}^3 branched over K_{II} , given by the representation of $\pi_1(\mathbb{R}^3 - K_{II})$ onto the dihedral group of order $2p$ sending meridians to elements of order 2, is \mathbb{R}^3 , for any odd sequence I and any odd integer $p \geq 3$.

PROOF. Since by Proposition 5 the string (\mathbb{R}^3, K_{II}) is almost unknotted it is possible to find a sequence $\{\mathbb{B}_i\}_{i=1}^\infty$ of closed 3-cells in \mathbb{R}^3 such that (i) $\mathbb{B}_i \subset \text{Int}\mathbb{B}_{i+1}$; (ii) $\cup_{i=1}^\infty \mathbb{B}_i = \mathbb{R}^3$; and (iii) $\mathbb{B}_i \cap K_{II}$ is the disjoint union of two properly embedded arcs lying in a properly embedded disk in \mathbb{B}_i , for any $i \geq 1$. Since the p -fold irregular covering of \mathbb{B}_i branched over $\mathbb{B}_i \cap K_{II}$ is a closed 3-cell, it follows that the p -fold irregular covering of \mathbb{R}^3 branched over K_{II} is an increasing union of closed 3-cells. Hence it is homeomorphic to \mathbb{R}^3 by a Theorem of Brown [3]. \square

3. Characterizing Strings Lying in the Unknot

The following result is evident.

PROPOSITION 8. *If the string (\mathbb{R}^3, K) lies in the unknot then, for all $n \geq 2$, the n -fold cyclic covering of \mathbb{R}^3 branched over K lies in \mathbb{S}^3 .*

Proposition 8 gives the key to obtain examples of strings not lying in the unknot.

LEMMA 9. *Let M be a closed 3-manifold and let o be a point in M . If $M - o$ can be embedded in \mathbb{S}^3 , then M is homeomorphic to \mathbb{S}^3 .*

PROOF. Let \mathbb{B} be a tame closed 3-cell centered at o . If $h : M - o \rightarrow \mathbb{S}^3$ is an embedding, then by the generalized Schoenflies Theorem ([11],[4]), the closure of each complementary domain of $\mathbb{S}^3 - h(\text{Bd}\mathbb{B})$ is a closed 3-cell. It follows that $M - \text{Int}\mathbb{B}$ is a closed 3-cell. Hence M is homeomorphic to \mathbb{S}^3 . \square

THEOREM 10. *If a non trivial string (\mathbb{R}^3, K) lies in the unknot then the knot $(\mathbb{R}^3 + \infty, K + \infty)$ is wild.*

PROOF. If $(\mathbb{R}^3 + \infty, K + \infty)$ is a tame non trivial knot then the 2-fold covering of $\mathbb{R}^3 + \infty$ branched over $K + \infty$ is a closed 3-manifold M not homeomorphic to \mathbb{S}^3 . But if (\mathbb{R}^3, K) lies in the unknot, then, by Proposition 8 $M - \{\text{point}\}$ can be embedded in \mathbb{S}^3 , which contradicts Lemma 9. \square

COROLLARY 11. *Let (\mathbb{S}^3, N) be a non trivial (tame) knot and let o be a point in N . Then the string $(\mathbb{S}^3 - o, N - o)$ fails to lie in the unknot.*

However $(\mathbb{S}^3 - \mathbf{o}, N - \mathbf{o})$ lies obviously in the knot (\mathbb{S}^3, N) . If it is required to obtain examples of strings not lying in *any* (tame) knot, one can take an infinite sum of non trivial (tame) knots.

THEOREM 12. *An infinite sum of non trivial (tame) knots is a string which fails to lie in any (tame) knot*

PROOF. The 2-fold covering of such a string will be an infinite connected sum of closed 3-manifolds, and again, this open 3-manifold M fails

to lie in any closed 3-manifold X . Because if X has, say, n prime components we can look at the embedding of a bicollared 2-sphere of M separating from M a compact 3-manifold with more than n prime components. \square

A more difficult question is *to obtain almost unknotted strings not lying in any knot*. Corollary 38 offers uncountably many almost unknotted strings not lying in any (tame) knot.

A subset X of an n -manifold M is said to be *cellular* if there exists a sequence $\{\mathbb{B}_i\}_{i=1}^{\infty}$ of n -cells in M such that $\mathbb{B}_{i+1} \subset \text{Int}\mathbb{B}_i$ ($i = 1, 2, \dots$) and $X = \bigcap_{i=1}^{\infty} \mathbb{B}_i$. Clearly, cellular sets are compact and connected. They are also *pointlike* [5], that is $M - X$ is homeomorphic to the complement of some point in M . The concepts of "pointlike" and "cellular" coincide in \mathbb{S}^n for compact, connected sets.

PROPOSITION 13. *The complement of the image of an embedding of \mathbb{R}^n into \mathbb{S}^n is cellular.*

PROOF. By invariance of domain, the image of the embedding is open. By Jordan separation Theorem, its complement is connected. Therefore, it is a connected compact set. It is also pointlike. Therefore, it is cellular. Alternatively, one can represent \mathbb{R}^n as a union of an increasing sequence of closed n -cells with bicollared boundary, and use the generalized Schoenflies Theorem [3] to show that the complement of the image of an embedding of \mathbb{R}^n into \mathbb{S}^n is cellular. \square

As a Corollary we characterize the strings lying in the unknot as follows.

COROLLARY 14. *If (\mathbb{R}^3, K) is a string lying in the unknot $(\mathbb{S}^3, \mathbb{S}^1)$ then there exists a space \mathbf{X} such that (i) \mathbf{X} is cellularly embedded in \mathbb{S}^3 ; (ii) $\mathbf{X} \cap \mathbb{S}^1$ is an arc or a point; and (iii) $(\mathbb{S}^3 - \mathbf{X}, \mathbb{S}^1 - \mathbf{X})$ is homeomorphic to (\mathbb{R}^3, K) .*

PROOF. By Proposition 13 the complement \mathbf{X} in \mathbb{S}^3 of the image of \mathbb{R}^3 is a cellular set. Therefore, \mathbf{X} is a space cellularly embedded in \mathbb{S}^3 such that $(\mathbb{S}^3 - \mathbf{X}, \mathbb{S}^1 - \mathbf{X})$ is homeomorphic to (\mathbb{R}^3, K) . Also by Proposition 13, the complement in \mathbb{S}^1 of the image of K is a cellular subset of \mathbb{S}^1 ; hence a point or an arc. \square

DEFINITION 15. *A space \mathbf{X} such that (i) \mathbf{X} is cellularly embedded in \mathbb{S}^3 ; and (ii) $\mathbf{X} \cap \mathbb{S}^1$ is an arc or a point, will be called a residual space.*

4. Embedding the SL-Continuum with Only One End Point in S^3

According to Corollary 14, to obtain examples of strings (\mathbb{R}^3, K) lying in (S^3, S^1) we need to select some residual continuum \mathbf{X} . A good candidate is Bing's SL-continuum \mathbf{S} with only one end point. An abstract definition of \mathbf{S} is the following. Let (C_n, g_n, \mathbb{N}) be the inverse system where, for every positive integer n , C_n is the interval $[-1, 1]$ and $g_n : C_n \rightarrow C_{n-1}$ is defined by $g_n(x) = 2x^2 - 1$. Then \mathbf{S} is the inverse limit of this inverse system. The end point \mathbf{o} is $(1, 1, \dots)$.

Bing's definition of \mathbf{S} (equivalent to the abstract definition) is the following subspace of \mathbb{R}^2 . Let C be the Cantor set in the (x, y) -plane, which is obtained by deleting the middle open third of the interval from $(0, 0)$ to $(1, 0)$, deleting the middle open thirds of the remaining intervals, ... Let \mathbf{S}_0 be the union of all semicircles in the upper half plane with both end points on C which are symmetric with respect to the line $x = 1/2$. Let \mathbf{S}_i ($i = 1, 2, \dots$) be the union of all semicircles in the lower half plane with both

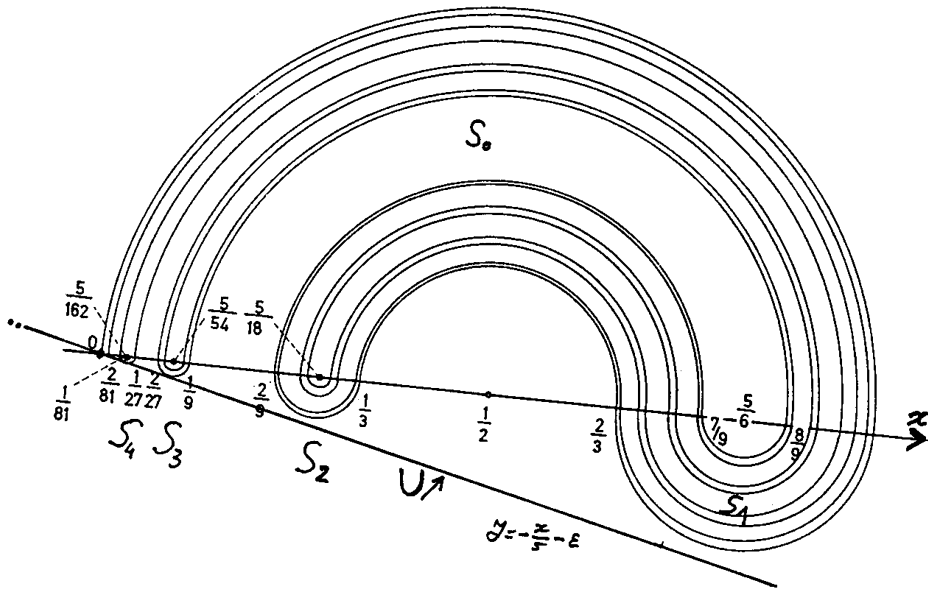

Fig. 7. The snake-like continuum \mathbf{S} .

end points on C which are symmetric with respect to the line $x = 5/(3^i \cdot 2)$. Then $\mathbf{S} = \cup_{i=0}^{\infty} \mathbf{S}_i$. The SL -continuum without end points \mathbf{W} is the union of \mathbf{S} and the continuum which is symmetric to it with respect to the origin. The only end point of \mathbf{S} is the origin \mathbf{o} . Figure 7 depicts part of \mathbf{S} .

We assume $\mathbb{R}^2 \subset \mathbb{R}^3 \subset \mathbb{R}^3 + \infty = \mathbb{S}^3$. Thus \mathbf{S} and \mathbf{W} are embedded in \mathbb{S}^3 . We embed the unknot U in \mathbb{S}^3 as the subset $\{(x, y, 0) : y = -x(1 + 0.1)/5\} + \infty$. Thus $U \cap \mathbf{S} = \mathbf{o}$ (see Figure 7).

DEFINITION 16. The triple $(\mathbb{S}^3, \mathbf{S}, U)$ is called *the standard embedding*.

We now modify the standard embedding to obtain some others.

DEFINITION 17. Given an integer sequence $I = \{n_i\}_{i=1}^{\infty}$ and a sequence of half integers $J = \{m_i\}_{i=1}^{\infty}$, we define the embedding $(\mathbb{S}^3, \mathbf{S}_J, U_I)$ such that $U_I \cap \mathbf{S} = \mathbf{o}$ as follows. Take the standard embedding $(\mathbb{S}^3, \mathbf{S}, U)$ shown in Figure 7 and place U_I in \mathbb{S}^3 in such a way that it coincides with the U "away" of the sets \mathbf{S}_i ($i = 1, 2, \dots$), and "links" \mathbf{S}_i ($i = 1, 2, \dots$) n_i times as shown in Figure 8. (If $n_i \geq 1$ there are n_i right handed twists; left handed, if $n_i \leq -1$; no linking if $n_i = 0$.) Simultaneously, twist the set \mathbf{S}_i m_i times.

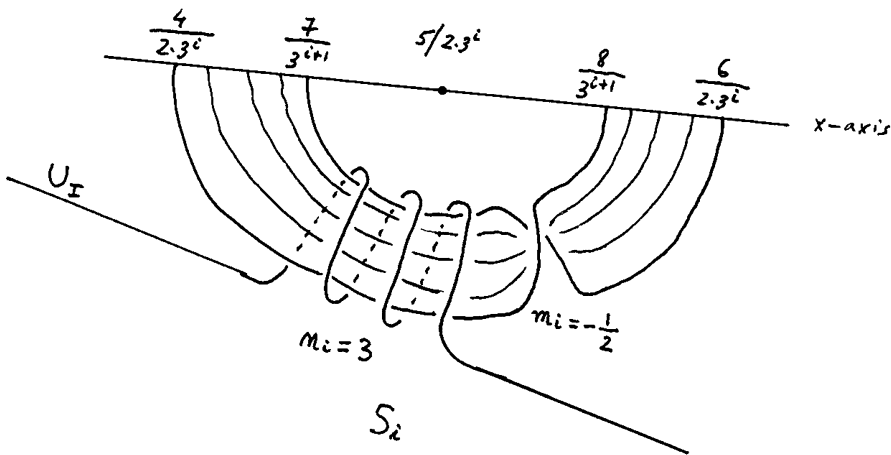

Fig. 8. Modifying the embedding of S .

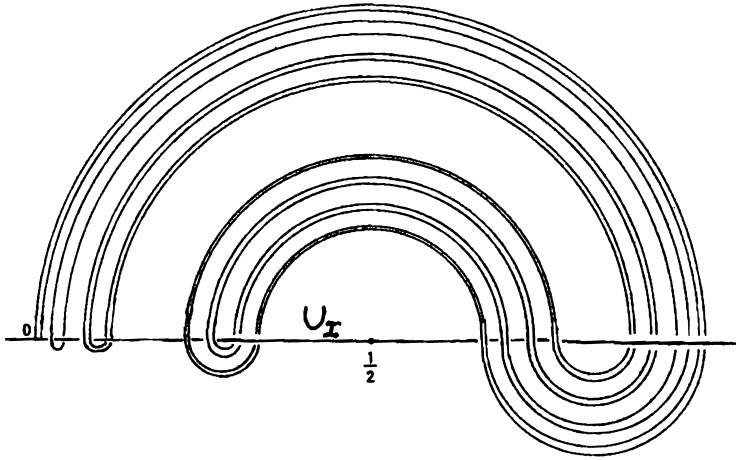

Fig. 9. $J = \{0, 0, 0, \dots\}, I = \{1, 1, 1, \dots\}$.

That is, cut it along the plane $x = 5/(3^i \cdot 2)$, twist one of the ends by $2m_i$ half twists and paste it back again (see Figure 8).

For instance, in Figure 9 we see $(\mathbb{S}^3, \mathbf{S}_J, U_I)$ for $J = \{0, 0, 0, \dots\}$ and $I = \{1, 1, 1, \dots\}$.

5. Non Trivial Strings Lying in the Unknot

THEOREM 18. *Given an integer sequence $I = \{n_i\}_{i=1}^\infty$ and a sequence of half integers $J = \{m_i\}_{i=1}^\infty$, the string (\mathbb{R}^3, K_{JI}) lies in the unknot. In fact the string (\mathbb{R}^3, K_{JI}) is homeomorphic to $(\mathbb{S}^3 - \mathbf{S}_J, U_I - \mathbf{o})$. If the sequence I is an odd sequence, the string (\mathbb{R}^3, K_{JI}) is not trivial.*

PROOF. Consider (\mathbb{R}^3, K_{JI}) of Figure 1. The vertical lines Σ_i represent a sequence of concentric 2-spheres with common center at some point at the left of the picture. They divide \mathbb{R}^3 in the disjoint union of a 3-ball, denoted C_0 , and a sequence $\{C_i\}_{i=1}^\infty$ of 3-shells (hollow balls). The *standard shell* C_i is depicted in Figure 10. The 3-braid b_i has been displayed as boxes $n_i = (\sigma_1 \sigma_2^2 \sigma_1)^{-n_i}$ and $m_i = \sigma_2^{-2m_i}$. To reconstruct (\mathbb{R}^3, K_{JI}) one have to identify Σ_i^+ in C_{i-1} with Σ_i^- in C_i by an orientation reversing

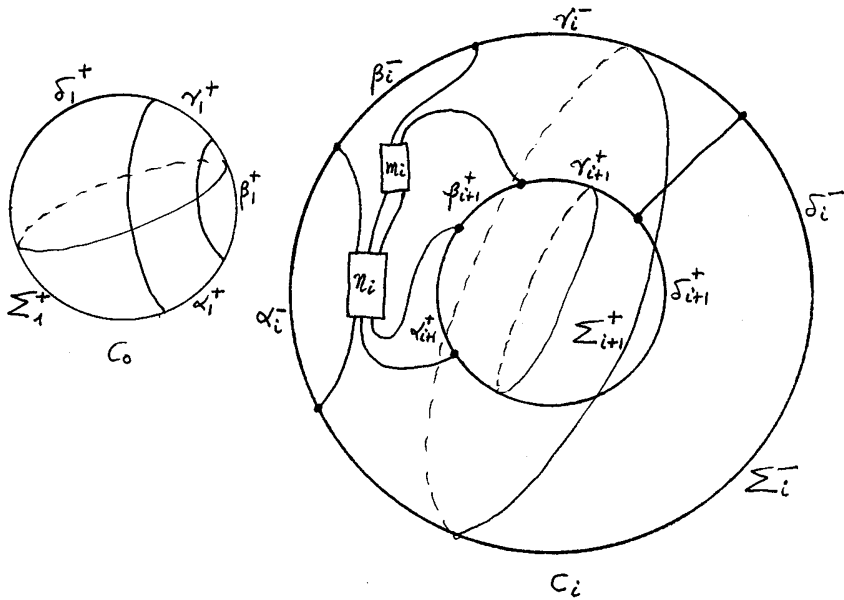

Fig. 10. The standard shell.

homeomorphism sending the arcs $\{\alpha_i^+, \beta_i^+, \gamma_i^+, \delta_i^+\}$ in the 2-sphere Σ_i^+ to the arcs $\{\alpha_i^-, \beta_i^-, \gamma_i^-, \delta_i^-\}$ in the 2-sphere Σ_i^- , for $i = 1, 2, \dots$.

Now we "stretch" $C_i \cap K_{JI}$, as depicted in Figure 11, forcing K_{JI} to become the unknot. This process converts the round sphere Σ_{i+1}^+ into an elongated sphere $\widehat{\Sigma}_{i+1}^+$, twisted m_i times (notice the m_i twisting in the right lower part of $\widehat{\Sigma}_{i+1}$). Denote the deformed 3-shell of Figure 11 by \widehat{C}_i .

Next, we reconstruct (\mathbb{R}^3, K_{JI}) by identifying $\widehat{\Sigma}_i^+$ in \widehat{C}_{i-1} with $\widehat{\Sigma}_i^-$ in \widehat{C}_i so that $\{\alpha_i^+, \beta_i^+, \gamma_i^+, \delta_i^+\}$ is identified with $\{\alpha_i^-, \beta_i^-, \gamma_i^-, \delta_i^-\}$, for $i = 1, 2, \dots$. Let $f_i : \widehat{\Sigma}_i^+ \rightarrow \widehat{\Sigma}_i^-$ be the identification map.

Start with $\widehat{C}_0 \cup \widehat{C}_1 \subset \mathbb{S}^3$ shown in Figure 12. Now $\mathbb{S}^3 - \text{Int}(\widehat{C}_0 \cup \widehat{C}_1)$ is a closed 3-cell \mathbb{B}_2 such that $Bd\mathbb{B}_2$ is $\widehat{\Sigma}_2^+$. We extend $f_2^{-1} : \widehat{\Sigma}_2^- \rightarrow \widehat{\Sigma}_2^+ = Bd\mathbb{B}_2$ to an embedding g_2 of \widehat{C}_2 in \mathbb{B}_2 .

Now $\mathbb{S}^3 - \text{Int}(\widehat{C}_0 \cup \widehat{C}_1 \cup g_2\widehat{C}_2)$ is a closed 3-cell \mathbb{B}_3 such that $Bd\mathbb{B}_3$ is $g_2\widehat{\Sigma}_3^+$. We extend $f_2^{-1} \circ f_3^{-1} : \widehat{\Sigma}_3^- \rightarrow \widehat{\Sigma}_3^+ \rightarrow g_2\widehat{\Sigma}_3^+ = Bd\mathbb{B}_3$ to an embedding of \widehat{C}_3 in \mathbb{B}_3, \dots . If we are careful with the extensions g_i we can assume that the intersection $\cap_{i=2}^\infty \mathbb{B}_i$ is 1-dimensional.

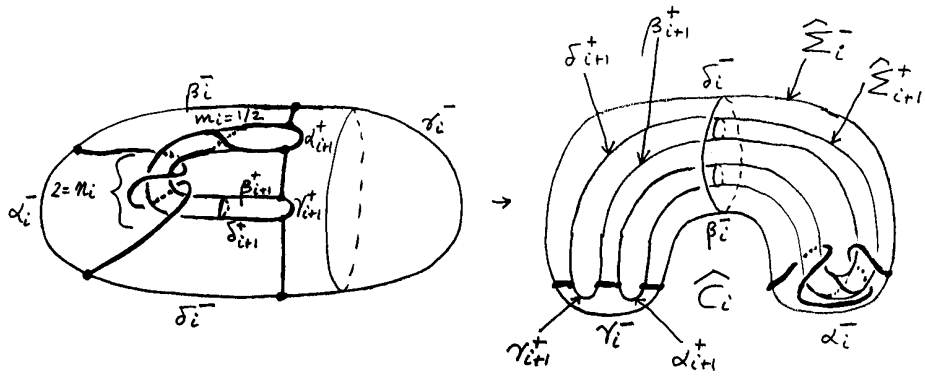

Fig. 11. Stretching the string.

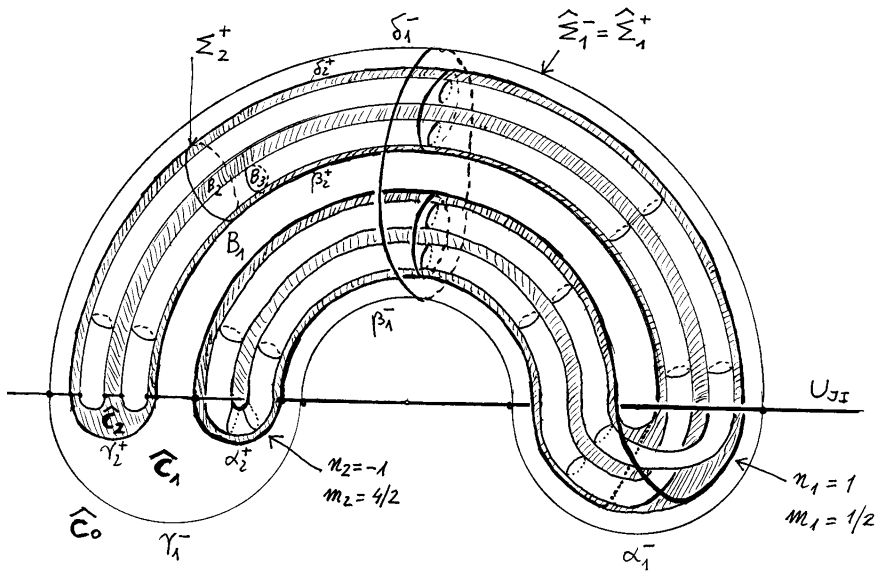

Fig. 12. Reconstructing the string: $m_1 = 1/2$; $n_1 = 1$; $m_2 = 4/2$; $n_2 = -1$.

It is not difficult to see that $(\mathbb{S}^3, \cap_{i=2}^\infty \mathbb{B}_i)$ is homeomorphic to $(\mathbb{S}^3, \mathbf{S}_J)$, $J = \{m_i\}_{i=1}^\infty$. This construction shows that (\mathbb{R}^3, K_{JI}) is homeomorphic to $(\mathbb{S}^3 - \mathbf{S}_J, U_I - \mathbf{o})$. \square

6. The 2-Fold Covering of \mathbb{R}^3 Branched Over K_{JI}

Since by Theorem 18 (\mathbb{R}^3, K_{JI}) is homeomorphic to $(\mathbb{S}^3 - \mathbf{S}_J, U_I - \mathbf{o})$, the 2-fold covering \tilde{K}_{JI} of \mathbb{R}^3 branched over K_{JI} is homeomorphic to $\mathbb{S}^3 - p_I^{-1}\mathbf{S}_J$ where $p_I : \mathbb{S}^3 \rightarrow \mathbb{S}^3$ is the standard 2-fold covering branched over the unknot U_I . We have:

THEOREM 19. *The 2-fold covering \tilde{K}_{JI} of \mathbb{R}^3 branched over K_{JI} is the complement in \mathbb{S}^3 of the continuum $\tilde{\mathbf{S}}_{JI}$ depicted in Figure 13, where $p_i = m_i - n_i/2$. The symbol p_i in Figure 13 stands for $2p_i$ half twists as in*

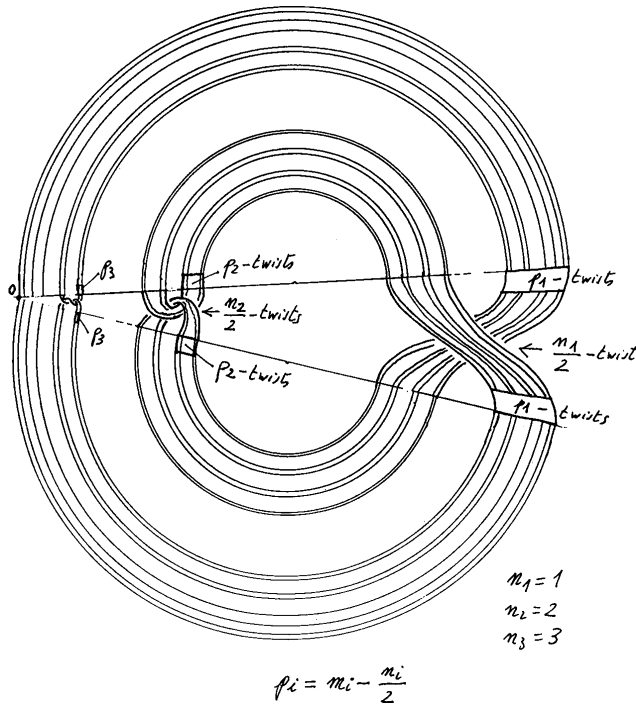

Fig. 13. The continuum $\tilde{\mathbf{S}}_{JI}$: $J = \{m_i\}_{i=1}^\infty, I = \{n_i\}_{i=1}^\infty$.

Definition 17.

PROOF. It is obvious that $\tilde{\mathbf{S}}_{JI} = p_I^{-1}\mathbf{S}_J$. Note that when $\tilde{\mathbf{S}}_{JI}$ is projected onto \mathbf{S}_J under the map p_I , the $(n_i/2)$ -twist in Figure 13, gives rise to the n_i -times linking of Figure 8, plus an additional $(n_i/2)$ -twisting in the set S_i of Figure 8. For this reason p_i is taken to be $m_i - n_i/2$ in order to compensate for the extra $(n_i/2)$ -twisting. \square

COROLLARY 20. *If the sequence I is even, the continuum $\tilde{\mathbf{S}}_{JI}$ is homeomorphic to Bing's SL continuum without end points \mathbf{W} .*

REMARK 21. The embedding of \mathbf{W} in \mathbb{S}^3 is cellular. The embeddings $(\mathbb{S}^3, \tilde{\mathbf{S}}_{JI})$ are not cellular, in general.

On the other hand, we have seen, in the proof of Theorem 18, that \mathbf{S}_J is the intersection $\cap_{i=1}^\infty \mathbb{B}_i$, where \mathbb{B}_i is a closed 3-cell in \mathbb{S}^3 intersecting the branching set U_I of $p_I : \mathbb{S}^3 \rightarrow \mathbb{S}^3$ in two trivial arcs (see Figure 12). Then it follows that $\tilde{\mathbf{S}}_{JI}$ is the intersection $\cap_{i=1}^\infty \mathbb{V}_i$ of a sequence $\{\mathbb{V}_i\}_{i=1}^\infty$ of solid tori in \mathbb{S}^3 . (A sequence like that is called a *defining sequence* for \mathbf{S}_{JI} , see [5].) The way \mathbb{V}_{i+1} lies in \mathbb{V}_i is shown in Figure 14. In this picture we see also the restriction of $p_I : \mathbb{S}^3 \rightarrow \mathbb{S}^3$ to the solid tori pair $(\mathbb{V}_i, \mathbb{V}_{i+1})$. Therefore, we have:

THEOREM 22. *$\tilde{\mathbf{S}}_{JI}$ is $\cap_{i=1}^\infty \mathbb{V}_i$ where $\{\mathbb{V}_i\}_{i=1}^\infty$ is a defining sequence of solid tori in \mathbb{S}^3 such that \mathbb{V}_{i+1} lies in $Int\mathbb{V}_i$ as shown in Figure 14.*

COROLLARY 23. *$\tilde{\mathbf{S}}_{II}$ is $\cap_{i=1}^\infty \mathbb{V}_i$ where $\{\mathbb{V}_i\}_{i=1}^\infty$ is a defining sequence of solid tori in \mathbb{S}^3 such that \mathbb{V}_i is unknotted in \mathbb{S}^3 for every $i \geq 1$.*

PROOF. \mathbb{V}_1 is unknotted in \mathbb{S}^3 . By induction, suppose \mathbb{V}_i is unknotted in \mathbb{S}^3 , and suppose the longitude δ_i^- of \mathbb{V}_i is nulhomologous in $\mathbb{S}^3 - Int\mathbb{V}_i$. The way \mathbb{V}_{i+1} lies in \mathbb{V}_i , and the way \mathbb{V}_i lies in \mathbb{S}^3 , is then shown in Figure 14. Then, certainly, \mathbb{V}_{i+1} is unknotted in \mathbb{S}^3 . We need to show that the longitude δ_{i+1}^- of \mathbb{V}_{i+1} is nulhomologous in $\mathbb{S}^3 - Int\mathbb{V}_{i+1}$. Then, referring again to Figure 14, $2p_i = 2m_i - n_i$ (compare Theorem 19). Since $m_i = n_i$ by hypothesis, it follows that $2p_i$ equals n_i . Now $2p_i$ is the "framing" of the longitude $\delta_{i+1}^+ = \delta_{i+1}^-$ of \mathbb{V}_{i+1} in \mathbb{S}^3 , and $-n_i$ is the number of complete twists of \mathbb{V}_{i+1} as projected in Figure 14. Therefore δ_{i+1}^- is nulhomologous

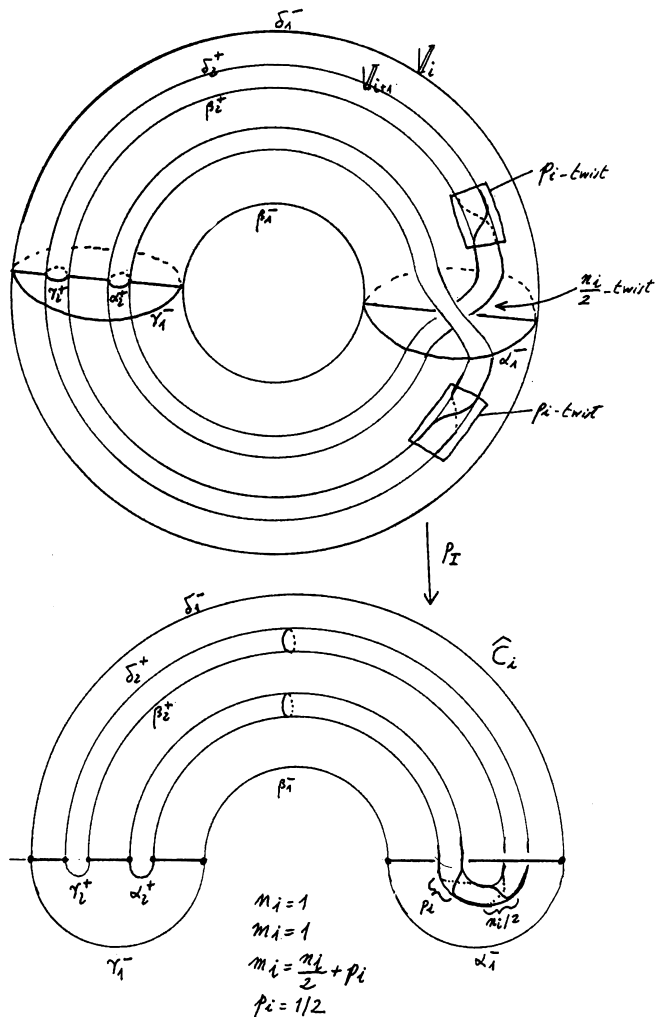

Fig. 14. The restriction of $p_I : \mathbb{S}^3 \rightarrow \mathbb{S}^3$ to the solid tori pair $(\mathbb{V}_i, \mathbb{V}_{i+1})$.

in \mathbb{S}^3 . \square

COROLLARY 24. $\mathbb{S}^3 - \tilde{\mathbf{S}}_{II}$ is an open, contractible 3-manifold if I has an even subsequence.

PROOF. If $\{\mathbb{V}_i\}_{i=1}^\infty$ is a defining sequence of solid tori in \mathbb{S}^3 such that

\mathbb{V}_i is unknotted in \mathbb{S}^3 for every $i \geq 1$ then $\mathbb{S}^3 - \text{Int}\mathbb{V}_i$ has the homotopy type of \mathbb{S}^1 . If, moreover, n_i is even, $\mathbb{S}^3 - \text{Int}\mathbb{V}_i$ is contractible in $\mathbb{S}^3 - \text{Int}\mathbb{V}_{i+1}$, because the core of the solid torus $\mathbb{S}^3 - \text{Int}\mathbb{V}_i$ is nullhomologous inside the solid torus $\mathbb{S}^3 - \text{Int}\mathbb{V}_{i+1}$. It follows that the manifold $\mathbb{S}^3 - \tilde{\mathbf{S}}_{II}$ is contractible because there is a subsequence of $\{\mathbb{S}^3 - V_i^2\}_{i=1}^\infty$ each member of which is contractible in the next member of the sequence $\{\mathbb{S}^3 - V_i^2\}_{i=1}^\infty$. \square

The following Corollary shows that the method used in Proposition 3 to see that the string (\mathbb{R}^3, K_{II}) is not trivial when I is odd does not work when I is even.

COROLLARY 25. *If the sequence I has an even subsequence, then $\pi_1(\mathbb{R}^3 - K_{II})$ has no transitive homomorphism into the symmetric group of $n \geq 3$ elements sending meridians to a product of transpositions.*

PROOF. Suppose $\omega : \pi_1(\mathbb{R}^3 - K_{II}) \rightarrow \Sigma_n$ is such a representation. Let M be the open 3-manifold which is the n -fold covering of \mathbb{R}^3 branched over K_{II} corresponding to the transitive representation ω . Because M can be interpreted as an orbifold covering of the orbifold $(\mathbb{R}^3, K_{II}, 2)$ with singular set K_{II} and isotropy cyclic of order two, it follows that M is covered by the universal orbifold covering of the orbifold $(\mathbb{R}^3, K_{II}, 2)$. But this universal orbifold covering coincides with the 2-fold covering \tilde{K}_{II} of \mathbb{R}^3 branched over K_{II} , because by Corollary 24 and Theorem 19 \tilde{K}_{II} is contractible. Hence $n = 2$. \square

For the particular sequences $I = J = \{1, 1, 1, \dots\}$ the intersection $\cap_{i=1}^\infty \{\mathbb{V}_i\}$ is the *standard embedding in \mathbb{S}^3 of the dyadic solenoid* (it helps to look at Figure 14). In fact, in the defining sequence $\{\mathbb{V}_i\}_{i=1}^\infty$ of solid tori in \mathbb{S}^3 the torus \mathbb{V}_{i+1} runs smoothly around inside \mathbb{V}_i two times longitudinally without folding back, and \mathbb{V}_i has cross diameter of less than $1/i$ [2], and also \mathbb{V}_i is unknotted in \mathbb{S}^3 for every $i \geq 1$. Therefore:

THEOREM 26. *The standard embedding in \mathbb{S}^3 of the dyadic solenoid is depicted in Figure 15. If the sequence I is odd, the continuum $\tilde{\mathbf{S}}_{JI}$ is homeomorphic to the dyadic solenoid.*

PROOF. When the sequence I is odd, compare Figure 15 with Figure 13. \square

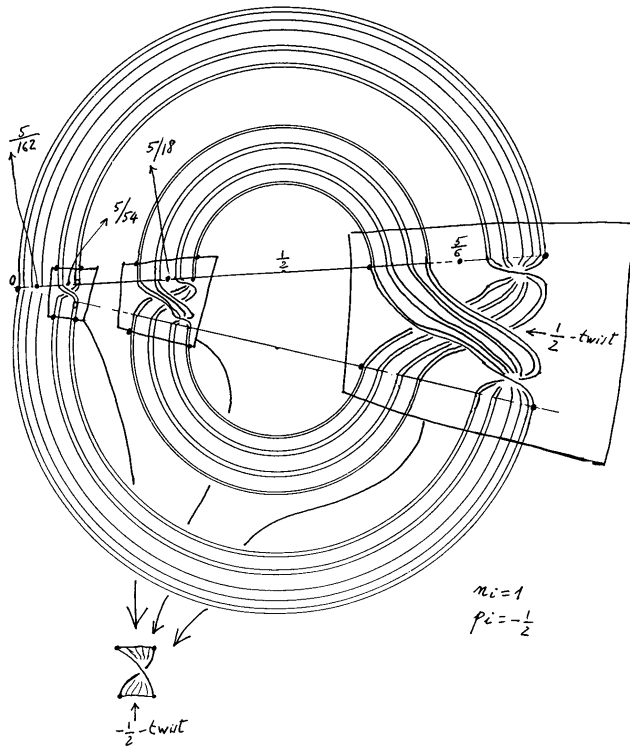

Fig. 15. The standard embedding in S^3 of the dyadic solenoid.

The standard embedding of the dyadic solenoid can be described as follows. Let C be the Cantor set in the (x, y) -plane, which is obtained by deleting the middle open third of the interval from $(0, 0)$ to $(1, 0)$, deleting the middle open thirds of the remaining intervals, ... Let C_0 be the union of all circles in the (x, y) -plane with both end points on C which are symmetric with respect to the line $x = 1/2$. Let D_i ($i = 1, 2, \dots$) be the disk in the (x, y, z) -space, which is orthogonal to the (x, y) -plane, with center $(5/(3^i \cdot 2), 0, 0)$ and radius $1/3^i$. Cut the (x, y, z) -space open along D_i , perform a negative half-twist in one of the sides of D_i and paste it back again. Do this simultaneously for every $i \geq 1$. The image of C_0 under this operation is the standard embedding of the dyadic solenoid (Figure 16).

When $I = J = \{2, 2, 2, \dots\}$ the intersection $\bigcap_{i=1}^{\infty} \{V_i\}$ is the *standard em-*

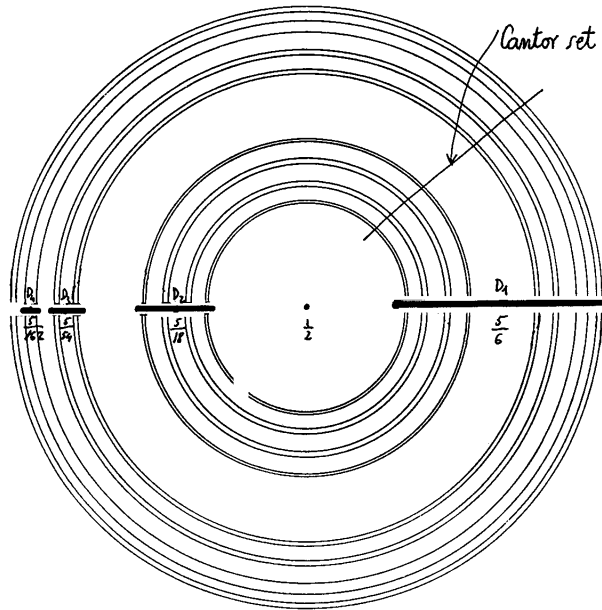

Fig. 16. The dyadic solenoid: cut open D_i ; half-twist one side; paste it back.

bedding in S^3 of the Whitehead continuum [5] (look at Figure 14). Therefore we have (Corollary 20):

THEOREM 27. *The standard embedding in S^3 of the Whitehead continuum is depicted in Figure 17. The Whitehead continuum is homeomorphic to Bing's snake-like continuum without end points W . If the sequence I is even, the continuum \tilde{S}_{JI} is homeomorphic to the Whitehead continuum.*

The standard embedding in S^3 of the Whitehead continuum can be described using Dehn surgery notation (Kirby calculus) as follows. Take Bing's SL continuum with no end points W defined as $S \cup S^*$, where S^* is the symmetric of S with respect to U (see Definition 16). Link the set S_i and its symmetric S_i^* with respect to U with a circle C_i , orthogonal to the (x,y) -plane and passing through the point $p_i = (5/(3^i \cdot 2), 0, 0)$ and its symmetric p_i^* with respect to U . Give to the circle C_i the surgery instruction -1 . Equivalently, cut S^3 open along a disk bounding C_i , give a complete right twist to one of the sides of the disk, and paste it back again. Do this simultaneously

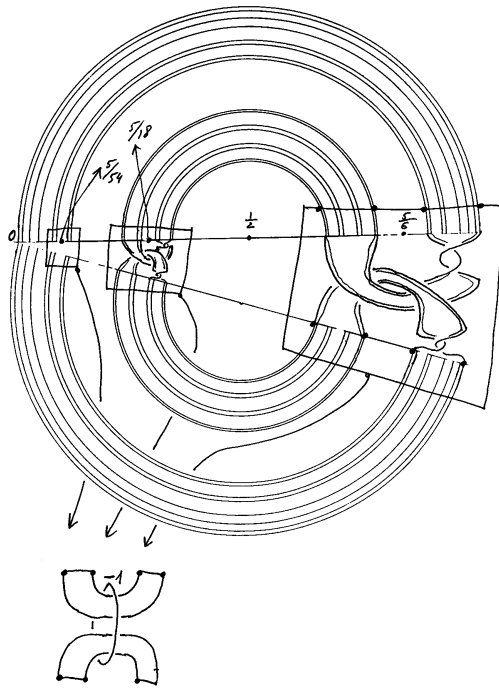

Fig. 17. The standard embedding in S^3 of the Whitehead continuum.

for every $i \geq 1$. The image of $\mathbf{W} = \mathbf{S} \cup \mathbf{S}^*$ under this operation is the standard embedding of the Whitehead continuum (Figure 18).

7. Uncountably Many Examples

Given a sequence $P = \{p_i\}_{i=1}^\infty$ of primes we define the three strings N_P^1 , N_P^2 , N_P^3 shown in Figures 19 and 20. The boxes B_2^k , $k = 1, 2, 3$, are depicted in Figures 21, 22 and 23, respectively. For an odd prime $p = 2m + 1$ the boxes B_p^k are independent of $k = 1, 2, 3$, that is, they depend only on m . The case $m = 2$ is depicted in Figure 24.

Using the methods explained before, the following Propositions are not difficult to prove (compare with [10]).

PROPOSITION 28. *For $k = 1, 2, 3$, the set N_P^k has one component if and only if P has an even subsequence. (Otherwise it is what we might call a*

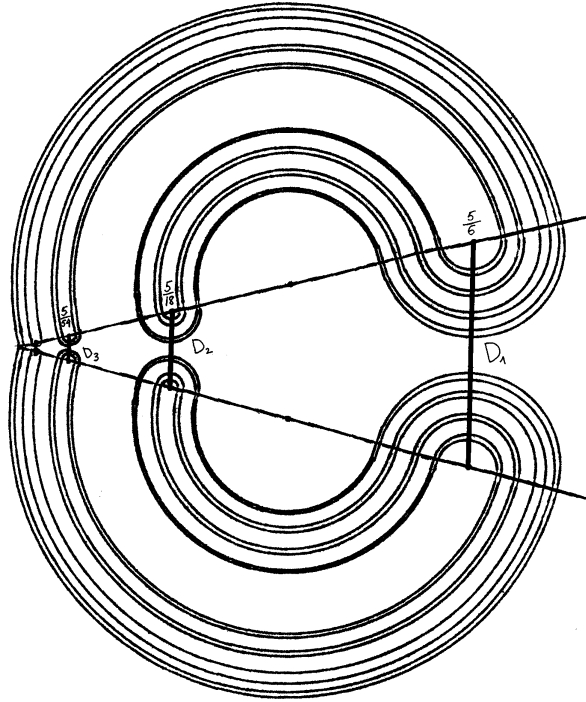

Fig. 18. The Whitehead continuum: cut along D_i , twist one side, and glue back.

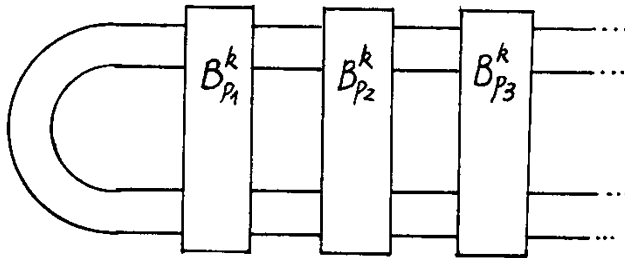

Fig. 19. The strings N_P^k , $k = 1, 2$.

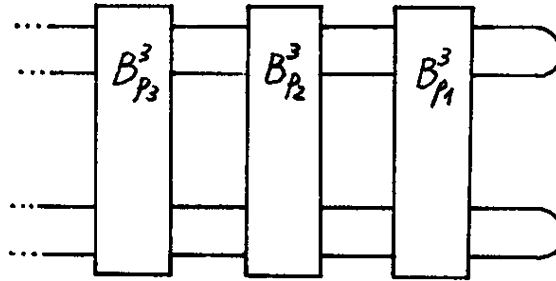

Fig. 20. The string N_P^3 .

link-string of two components.) Moreover, also for $k = 1, 2, 3$, the set N_P^k is almost unknotted (with the obvious definition when it has two components).

PROOF. It is obvious that N_P^3 is almost unknotted. Proving that N_P^k , $k = 1, 2$, are almost unknotted is more tricky. To help the reader, compare Figures 21 and 22 with Figure 2 and take into account the proof of Proposition 5. The best way to deal with Figure 24 is to experiment with cases $p = 3, 5$. An inductive argument presents itself immediately. \square

PROPOSITION 29. *For $k = 1, 2$, the 2-fold covering \tilde{N}_P^k of \mathbb{R}^3 branched over N_P^k is $\mathbb{S}^3 - \cap_{i=1}^\infty V_i^k$ where $\{V_i^k\}_{i=1}^\infty$ is a sequence of unknotted tori in \mathbb{S}^3 such that V_{i+1}^k lies in $\text{Int}V_i^k$ as shown in Figures 25 and 26 if $p_i = 2$, or in Figure 27 (case $p_i = 5$) if $p_i = 2m_i + 1$. The manifold \tilde{N}_P^2 is contractible if P has an even subsequence.*

PROOF. Compare with Figures 14 and 11 and proceed analogously. If P has an even subsequence, the manifold \tilde{N}_P^2 is contractible because there is a subsequence of $\{\mathbb{S}^3 - V_i^2\}_{i=1}^\infty$ each member of which is contractible in the next member of the sequence $\{\mathbb{S}^3 - V_i^2\}_{i=1}^\infty$ (see Figure 26). \square

REMARK 30. Given a sequence of odd primes p_1, p_2, p_3, \dots , an open contractible 3-manifold W is constructed in Section 3 of [9]. The manifold \tilde{N}_P^2 , where $P = \{p_1, 2, p_2, 2, p_3, 2, \dots\}$, is essentially the same as the manifold W .

PROPOSITION 31. *The 2-fold covering \tilde{N}_P^3 of \mathbb{R}^3 branched over N_P^3 is $\cup_{i=1}^\infty W_i$ where $\{W_i\}_{i=1}^\infty$ is an ascending sequence of tori such that W_i lies in*

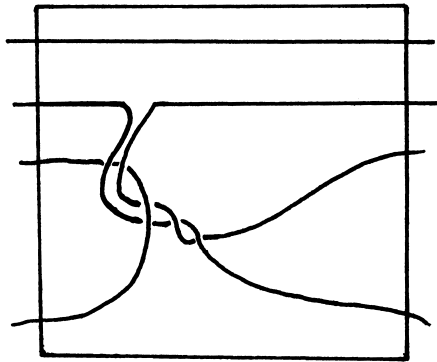

Fig. 21. The box B_2^1 .

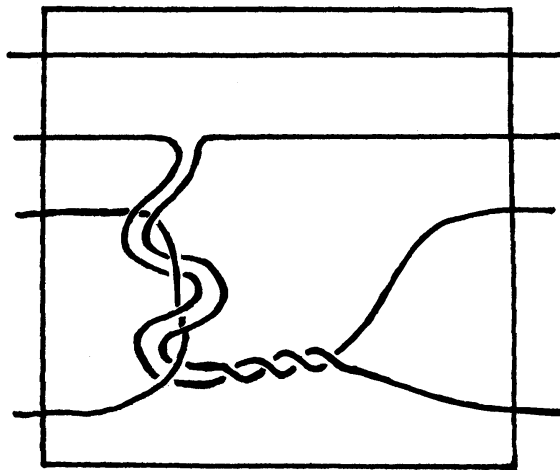
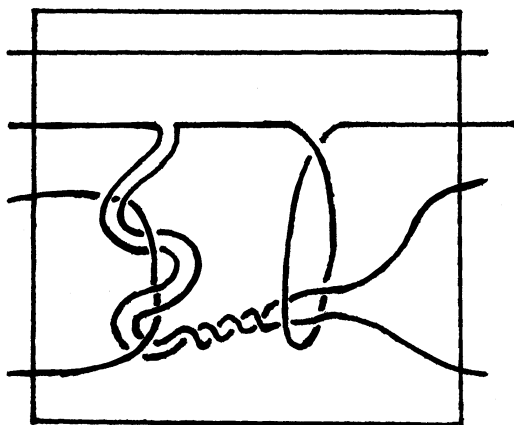
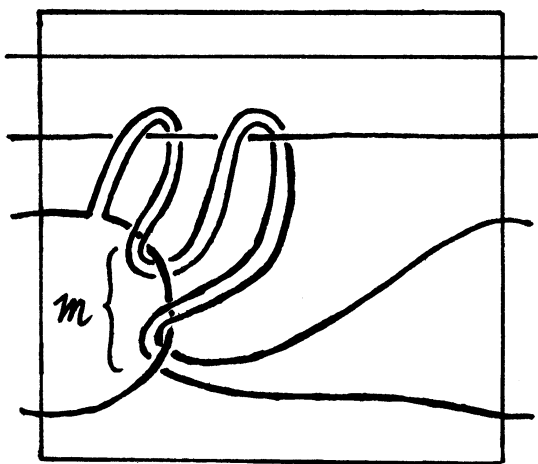

Fig. 22. The box B_2^2 .

$IntW_{i+1}$ as shown in Figure 28 if $p_i = 2$, or in Figure 29 if $p_i = 2m_i + 1$. The manifold \tilde{N}_P^3 is contractible if P has an even subsequence.

PROOF. Compare with Figures 14 and 11 and proceed similarly \square

REMARK 32. The open, contractible manifold \tilde{N}_P^3 , where $P = \{2, 2, 2, \dots\}$, is the manifold M' defined in Section 3 of [8]. Given sequences of

Fig. 23. The box B_2^3 .Fig. 24. The box B_p^k ; $p = 2m + 1$ ($= 5$).

odd primes p_1, p_2, p_3, \dots , the manifolds \tilde{N}_P^3 , where $P = \{p_1, 2, p_2, 2, p_3, 2, \dots\}$, are essentially the ones to which the main result of [8] applies. That is, the manifolds \tilde{N}_P^3 are not embeddable in \mathbb{S}^3 . In fact they are not embeddable in any closed, orientable 3-manifold [7].

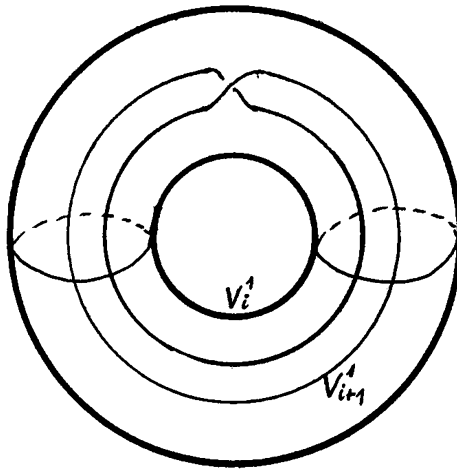

Fig. 25. $V_{i+1}^1 \subset \text{Int}V_i^1$.

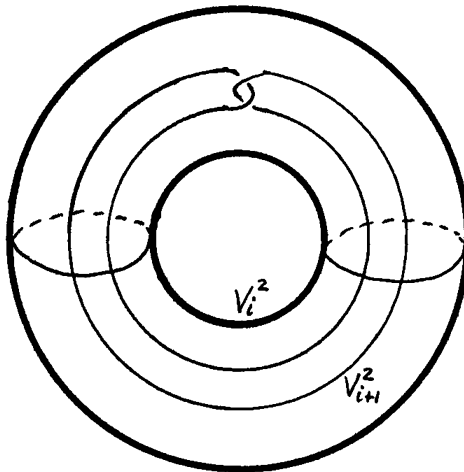

Fig. 26. $V_{i+1}^2 \subset \text{Int}V_i^2$.

Using Proposition 29 or a direct proof, like in Theorem 18, we have:

THEOREM 33. *For $k = 1, 2$, and for all P , the link-string (\mathbb{R}^3, N_P^k) lies in the unknot.*

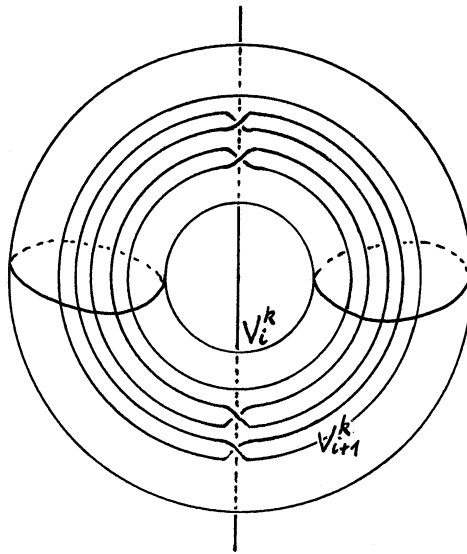

Fig. 27. $p_i = 2m_i + 1 (= 5)$; $k = 1, 2$.

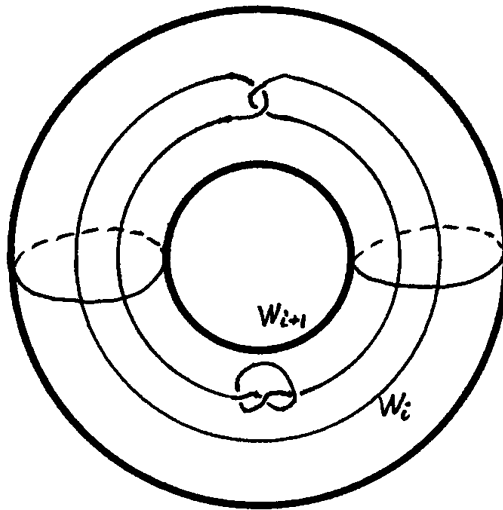

Fig. 28. $W_i \subset W_{i+1}$.

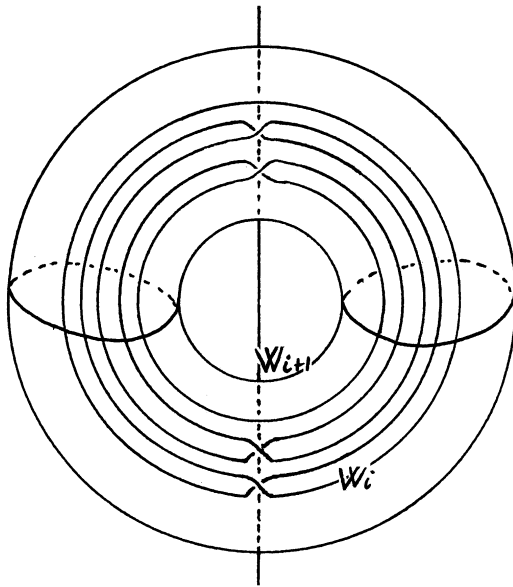

Fig. 29. $p_i = 2m_i + 1 (= 5)$.

REMARK 34. It is interesting to obtain the residual space X of (\mathbb{R}^3, N_P^1) for a given P . For instance, we have seen already that if P is the sequence $\{2, 2, 2, \dots\}$ then X is the SL-continuum with only one end point \mathbf{S} : this continuum is the quotient of the dyadic solenoid under an involution. Analogously, for any odd prime p the residual space X of (\mathbb{R}^3, N_P^1) , for the sequence $P = \{p, p, p, \dots\}$, is the quotient \mathbf{S}_p of the p -adic solenoid under an involution. The link-string $(\mathbb{R}^3, N_{\{3,3,3,\dots\}}^1)$ is depicted in Figure 30; here $(\mathbb{R}^3, N_{\{3,3,3,\dots\}}^1)$ is homeomorphic to $(\mathbb{S}^3 - \mathbf{S}_3, U - \mathbf{S}_3)$, where $(\mathbb{S}^3, \mathbf{S}_3, U)$ is shown in Figure 31. Notice that \mathbf{S}_p has two end-points.

THEOREM 35. *Corresponding to a sequence $p = \{p_i\}_{i=1}^\infty$ of distinct odd primes construct the sequence $P = \{p_1, 2, p_2, 2, p_3, 2, \dots\}$ which is obtained from p by alternating a subsequence of 2's. Then, (\mathbb{R}^3, N_P^3) is a (one component) string which fails to lie in any (tame) knot.*

PROOF. By Remark 32 the manifold \tilde{N}_P^3 cannot be embedded in any closed, oriented 3-manifold. Therefore, the string (\mathbb{R}^3, N_P^3) fails to lie in any (tame) knot (compare the proof of Theorem 12). \square

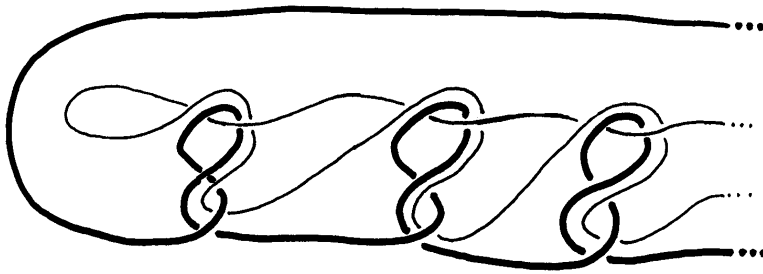

Fig. 30. The link-string $N_{\{3,3,3,\dots\}}^1$.

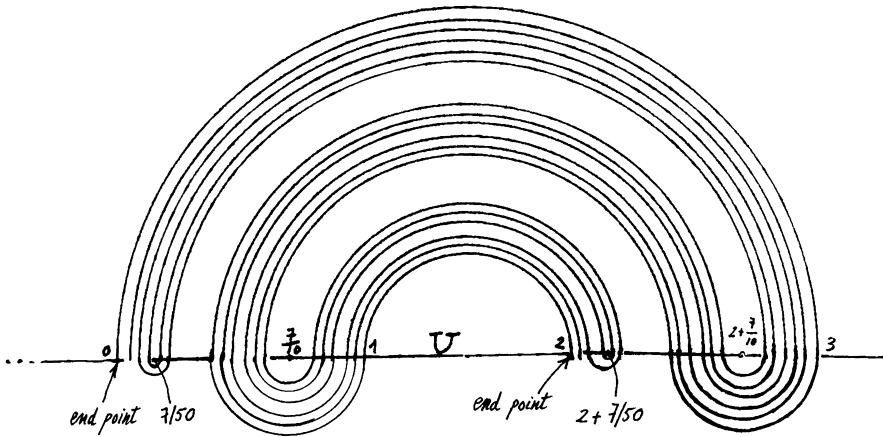

Fig. 31. The link-string $N_{\{3,3,3,\dots\}}^1$ again.

THEOREM 36. *Let $P = \{p_i\}_{i=1}^\infty$ and $Q = \{q_i\}_{i=1}^\infty$ be sequences of primes such that an infinite number of primes occur in P which do not occur in Q . Then, for $k = 1, 2, 3$, (\mathbb{R}^3, N_P^k) and (\mathbb{R}^3, N_Q^k) are topologically different.*

PROOF. It is enough to see that, for $k = 1, 2, 3$, \tilde{N}_P^k and \tilde{N}_Q^k are topologically different. The proof of this fact is essentially the same as the proof of Theorem 1 in [9], (see remark 30). \square

COROLLARY 37. *There exist uncountably many almost unknotted strings lying in the unknot, no two of which are homeomorphic.*

PROOF. Corresponding to a sequence $p = \{p_i\}_{i=1}^{\infty}$ of distinct odd primes construct the sequence $P = \{p_1, 2, p_2, 2, p_3, 2, \dots\}$ which is obtained from p by alternating a subsequence of 2's. Then, for $k = 1, 2$, (\mathbb{R}^3, N_P^k) is a (one component) string. The Corollary follows from Theorem 33 and Theorem 36 if one can ascertain that there is a set with cardinality of the continuum, each element of which is a sequence of the above type p and such that two such sequences have only a finite number of primes in common. This is asserted to be true in Section 3 of [9]. However, as far as I know, the proof of this fact depends on the axiom of Zorn, and is not constructive. \square

COROLLARY 38. *There exist uncountably many almost unknotted strings not lying in any (tame) knot, no two of which are homeomorphic.*

PROOF. Corresponding to a sequence $p = \{p_i\}_{i=1}^{\infty}$ of distinct odd primes construct the sequence $P = \{p_1, 2, p_2, 2, p_3, 2, \dots\}$ which is obtained from p by alternating a subsequence of 2's. Then, (\mathbb{R}^3, N_P^3) is a (one component) string. The Corollary follows from Theorem 35 and Theorem 36 as before. \square

References

- [1] Bing, R. H., Snake-like continua, *Duke Math. J.* **18** (1951), 653–663.
- [2] Bing, R. H., A simple closed curve is the only homogeneous bounded plane continuum that contains an arc, *Canad. J. Math.* **12** (1960), 209–230.
- [3] Brown, Morton, The monotone union of open n -cells is an open n -cell, *Proc. Amer. Math. Soc.* **12** (1961), 812–814.
- [4] Brown, Morton, A proof of the generalized Schoenflies theorem, *Bull. Amer. Math. Soc.* **66** (1960), 74–76.
- [5] Daverman, R. J., *Decompositions of manifolds*, Pure and Applied Mathematics, 124, Academic Press, Inc., Orlando, FL, 1986.
- [6] Fox, Ralph H., A remarkable simple closed curve, *Ann. of Math. (2)* **50** (1949), 264–265.
- [7] Haken, W., Some results on surfaces in 3-manifolds, 1968 *Studies in Modern Topology* pp. 39–98 *Math. Assoc. Amer.* (distributed by Prentice-Hall, Englewood Cliffs, N.J.)
- [8] Kister, J. M. and D. R. McMillan, Jr., Locally euclidean factors of E^4 which cannot be imbedded in E^3 , *Ann. of Math. (2)* **76** (1962), 541–546.
- [9] McMillan, D. R., Jr., Some contractible open 3-manifolds, *Trans. Amer. Math. Soc.* **102** (1962) 373–382.

- [10] Montesinos-Amilibia, J. M., Open 3-manifolds, wild subsets of S^3 and branched coverings, *Revista Matemática Complutense* (to appear).
- [11] Morse, Marston, A reduction of the Schoenflies extension problem, *Bull. Amer. Math. Soc.* **66** (1960) 113–115.

(Received September 30, 2002)

(Revised April 14, 2003)

Universidad Complutense de Madrid
Departamento de Geometría y Topología
Facultad de Ciencias Matemáticas
28040 Madrid, Spain